



INNOVATIVE FASTENER SOLUTIONS

DUPLEX
AISI 318LN & AISI 316L
Corrosion Resistant Solutions
developed
by GOEBEL
to Minimize CUI



“QUALITY THE FIRST TIME”



GOEBEL is the leading global specialist for innovative fastener solutions and we focus extra attention on corrosion resistant products. High-quality materials, such as Stainless 316L & DUPLEX 318LN, are what our new products are created from; which are self-tapping screws & waterproof rivets. These are widely used in offshore, oil & gas, marine applications and areas where chlorides are present. GOEBEL offers the largest range of innovative fastener solutions in the industry with locations around the world!

GOEBEL Locations Worldwide



UNITED STATES OF AMERICA

GOEBEL FASTENERS INC.
5650 GUHN ROAD, SUITE 110
HOUSTON, TX 77040
TEL.: +1- (713) 393 7007
E-MAIL: SALES@GOEBELFASTENERS.COM
WEB: WWW.GOEBELFASTENERS.COM

GERMANY

GOEBEL GMBH
SCHRAUB- UND VERBINDUNGSTECHNIK
MÜHLENSTRASSE 2-4
D-40699 ERKRATH
TEL.: +49 -(0) 211- 245000-0
FAX: +49- (0) 211- 245000-250
E-MAIL: DE@GOEBEL-GROUP.COM
WEB: WWW.GOEBEL-GROUP.COM

FRANCE

SOCIÉTÉ GOEBEL
VIS ET TECHNIQUES DE FIXATION
LE DÔME, 1 RUE DE LA HAYE, BP 12910
F-95731 ROISSY CDG CEDEX
TEL.: +33- (0) 1- 82887280
FAX: +33- (0) 1- 82887281
E-MAIL: FR@GOEBEL-GROUP.COM
WEB: WWW.GOEBEL-GROUP.COM

NETHERLANDS

GOEBEL BV
SCHROEF- EN VERBINDINGSTECHNIEK
ARESSTRAAT 13-02/04
NL-5048 CD TILBURG
TEL.: +31- (0) 13- 5720229
FAX: +31- (0) 13- 5720239
E-MAIL: NL@GOEBEL-GROUP.COM
WEB: WWW.GOEBEL-GROUP.COM

POLAND

GOEBEL POLSKA SP.Z.O.O.
UL.TOPOLOWA 1
PL-05-805 KANIE
TEL.: +48- (0) 22- 7593678
E-MAIL: PL@GOEBEL-GROUP.COM
WEB: WWW.GOEBEL-GROUP.COM

LATIN AMERICA

GOEBEL FASTENERS S DE RL DE CV
LOPE DE VEGA 209 COL. POLANCO
DEL. MIGUEL HIDALGO C.P. 11560
CIUDAD DE MÉXICO
TEL.: +52- 55 03 39 83
E-MAIL: VENTAS@GOEBELFASTENERS.MX
WEB: WWW.GOEBELFASTENERS.MX

CORROSION SOLUTIONS



Low quality fasteners can increase the chance of corrosion. Due to the physical geometry of the fasteners used and other rough surfaces, aggressive compounds such as chlorides (salts), acids (sulfuric acid) and alkaline solutions (cleaning lye) adhere better. The interaction of the compounds with the UV radiation drastically accelerates the process of pitting and crevice corrosion at these sites.



DUPLEX 318LN material is categorized by its excellent strength, ductility and fatigue resilience in combination with respectable overall, pitting, crevice and stress corrosion properties

DUPLEX 318LN & 316L Fasteners

GOEBEL Groups newly developed screws are made from DUPLEX AISI 318LN (1.4462) with a characteristic PRE 36 value; in addition our sealing CUP blind rivets are made of AISI 316L (1.4404) with a representative PRE 23-28 value. Both material qualities are solutions to minimize corrosion and decrease the chances of CUI as a result of the fastener application.



$PRE = 1 \times \%Cr + 3,3 \times \%Mo + 16 \times \%N$

“QUALITY THE FIRST TIME”



See The Full Video on Our Website: goebelfasteners.com

MODERN SOLUTIONS FOR TODAY'S INDUSTRY

Best in class corrosion resistance, reliable long-term performance, waterproof consistency and installation is quick into stainless steel metal jacketing applications.

In conjunction with insulation and construction, the implementation of a suitable metal jacketing system is very important as it provides the foundation for longevity, low maintenance costs, and reduced insulation heat losses. In addition, the importance in using the correct quality of fasteners such as banding, screws, and/or blind rivets plays a decisive role.

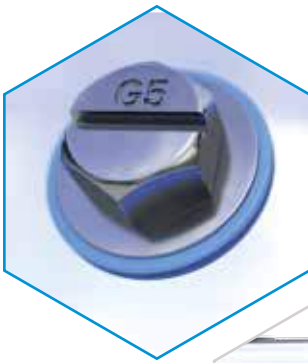

Self-Tapping Screws made from AISI 318LN **DUPLEX** material are 3x harder than AISI 304 or 316 due to the austenite and ferrite structure that ensures a reliable threaded connection without the risk of stripping the threads.

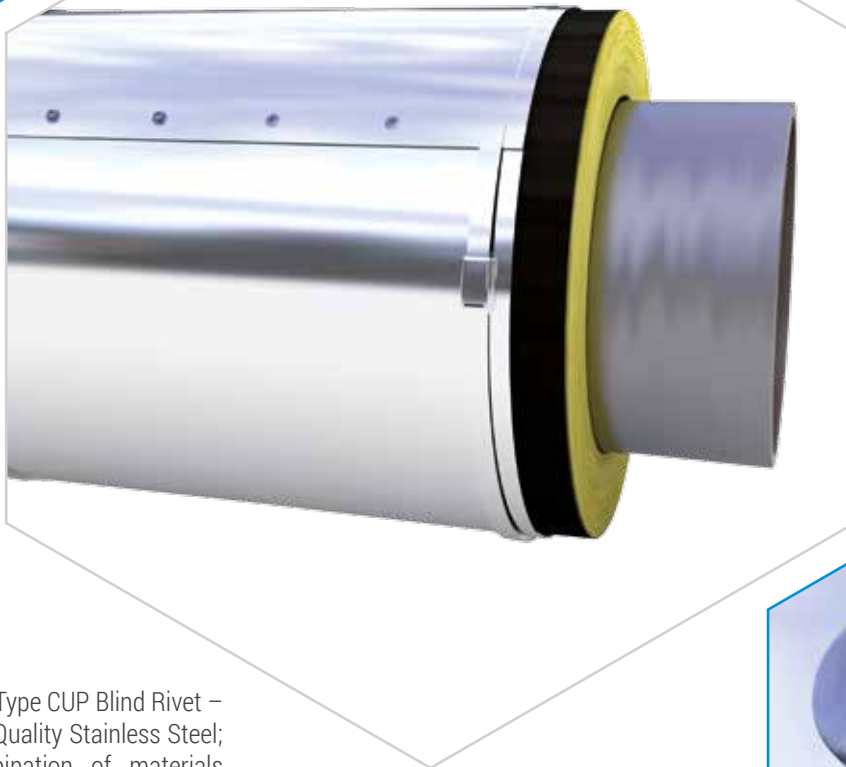

Sealed Type CUP Blind Rivet – Designed from Top Quality Stainless Steel; these are a combination of materials AISI 316L & AISI 318LN paired with a HNBR sealing washer resulting in a **100% waterproof** application.

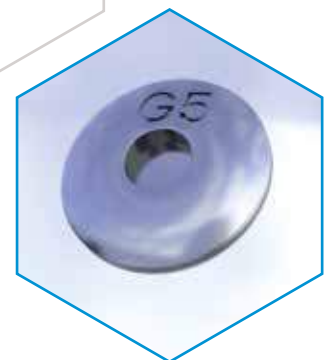

THE BENEFITS:

Safety and reliability remain paramount in our industry on a day to day basis. Our products are used in a large amount of critical applications that demand longevity, durability, and consistent quality. All these characteristics paired with our easy to identify unique designs, specifically the G5 mark and the blue HNBR sealing washer, make our fastener solutions a versatile option for a variety of applications.

SIGNIFICANT ADVANTAGES

DUPLEX 318LN SCREWS



Made from **DUPLEX**
AISI 318LN (1.4462)
Stainless Steel

PRE 36
(Pitting Resistance Equivalent)
beyond PRE 33
Seawater Resistant

3x harder versus
AISI 304 or 316
which in turn prevents
snapping or stripping
of the threads

Delta Seal Coating (Silver)
reduces friction while
increasing the corrosion
resistance of the screw

Additional functionality
of the Delta Seal Coating
is that it acts as a barrier
between materials

The A Type Thread
reduces the
installation time by 50%
versus ordinary
self-tapping screws

GOEBEL Quality
is easy to identify
by our unique
G5 Mark & Blue HNBR
Washer designs

DUPLEX
AISI 318LN (1.4462)
Stainless Steel
Bonded
HNBR Sealing Washer

HNBR Washer -
Higher Weathering Resistance

- Oxidation
- Ozone
- UV Radiation
- Mineral Oils
- Seawater
- Acidic Gases



SIGNIFICANT ADVANTAGES

316L SEALED TYPE CUP BLIND RIVETS



Body made from Stainless Steel AISI 316L (1.4404), PRE 23 -28

Mandrel made from **DUPLEX** AISI 318LN (1.4462) PRE 36 (Pitting Resistance Equivalent)

The Sealed Type CUP Blind Rivets combined with the HNBR Washer ensure a 100% waterproof connection. (Ordinary standard blind rivets are not waterproof)

High Grip Strength paired with High Shearing & Tensile Strength make this a Quality Solution

User friendly and easy to install design allows our rivets to be used with a variety of tool options to maximize job-site performance

HNBR Washer - Higher Weathering Resistance

- Oxidation
- Ozone
- UV Radiation
- Mineral Oils
- Seawater
- Acidic Gases



SLOTTED HEX-HEAD SELF-TAPPING SCREW

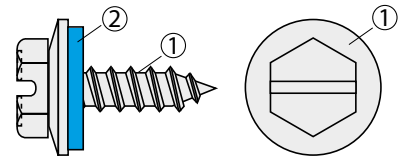

TECHNICAL DATA

	VALUES	REMARKS
Material	(1) DUPLEX - Stainless Steel (austenite/ferrite) (2) HNBR, Hydrogenated NBR	AISI 318LN / 1.4462 ASTM A182 F51
Description	Hex-Head-Self-Tapping-Screw with slot and assembled sealing (2) DUPLEX/HNBR boned washer	ISO 1479/ DIN 7976
Chemical Composition	(1) DUPLEX - Stainless Steel (austenite/ferrite) Chromium (Cr) 21.00 - 23.00 Nickel (Ni) 4.50 - 6.50 Molybdenum (Mo) 2.50 - 3.50 Manganese (Mn) 0.00 - 2.00 Silicon (Si) 0.00 - 1.00 Nitrogen (N) 0.10 - 0.22 Carbon (C) 0.00 - 0.03 Phosphorous (P) 0.00 - 0.03 Sulphur (S) 0.00 - 0.02 Iron (Fe) Balance	EN 10088-2:2014 1.4462
Temperature Range	(1) DUPLEX - Stainless Steel (austenite/ferrite) till +300°C (+572° F) till -50°C (-58° F) (2) HNBR - Hydrogenated NBR till +150°C (+302° F) till -30°C (-22° F) till +160°C (+320° F) (short term)	
PREN (Pitting Resistance Equivalent Number)	36 (Typical Value) SALTWATER RESISTANCE Alloyed stainless steel with a value beyond PREN 33 is considered to be seawater resistant.	ASTM G48 1 x %Cr + 3,3 x %Mo + 16 x %N
CPT Method E	(1) DUPLEX - Stainless Steel (austenite/ferrite) +40° C (104° F)	ASTM G48
CCT Method F	+20° C (68° F)	ASTM G48
CPT	+52° C ± 3° C (125.6° F/ 120.2° F till 13° F) CPT (ASTM G150) = Corrosion Pitting Temperature CCT (ASTM G48 Method E/F) = Critical Crevice Corrosion Temperature	ASTM G150
Tensile Strength	# 8 (Ø 4.2/4.3 mm) = lbf 1640 (7.3 kn) # 10 (Ø 4.8/4.9 mm)= lbf 2090 (9.3 kn)	Typical Values
Shearing Strength	# 8 (Ø 4.2/4.3 mm) = lbf 1080 (4.8 kn) # 10 (Ø 4.8/4.9 mm)= lbf 1325 (5.9 kn)	Typical Values
Magnetic (Magnetism)	existing	
Saltwater	(1) resistant (2) resistant	

GOEBEL SILVER GL SLIDE COATING - DELTA SEAL COATING



The Goebel Silver GL Slide Coating provides optimum sealing with multifunctional characteristics that guarantee exceptional corrosion protection while simultaneously reducing the screw-in resistance.

It is environmentally safe and free from any heavy metals that are harmful to one's health. The coating is available in various colors (i.e. silver, black, green and red).

Properties: superior adhesive strength, high level of hardness with good flexibility, high abrasion resistance, good resistance to weathering, (but not chalk resistant), high electrical insulating property (good protection against contact corrosion), superior resistance to chemicals proven in salt spray test, excellent resistance to sulphur dioxide proven in Kesternich test, excellent resistance to mineral oil, fuels, lubricants (i.e. grease, brake fluids, coolants, etc.)



SEALED BLIND RIVETS - CUP

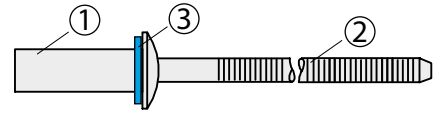

TECHNICAL DATA

	VALUES	REMARKS
	(1) Stainless Steel (austenite/ferrite) AISI 316LN	
CPT Method E	+20°C (+68°F)	ASTM G48
CCT Method F	<0°C (+32°F)	ASTM G48
CPT	+20°C ± 2°C (+68°F/ +64.4°F till +71.6°F)	ASTM G150
	(2) DUPLEX - Stainless Steel (austenite/ferrite)	
CPT Method E	+40°C (+104°F)	ASTM G48
CCT Method F	+20°C (+68°F)	ASTM G48
CPT	+52°C ± 3°C (+125.6°F/ 1+20.2°F till +13°F)	ASTM G150
Tensile Strength	Ø 1/8" (3.2 mm) = lbf 635 (2.82 kn) Ø 5/32" (4.0 mm) = lbf 1230 (5.47 kn) Ø 3/16" (4.8 mm) = lbf 1540 (6.35 kn)	
Shearing Strength	Ø 1/8" (3.2 mm) = lbf 525 (2.34 kn) Ø 5/32" (4.0 mm) = lbf 790 (3.51 kn) Ø 3/16" (4.8 mm) = lbf 1220 (5.43 kn)	
Magnetic (Magnetism)	(1) existing (2) existing	
Saltwater	(1) resistant (2) resistant (3) resistant	

SEALED BLIND RIVETS - CUP

DOME HEAD

JBD-CE-SERIES - CLOSED END

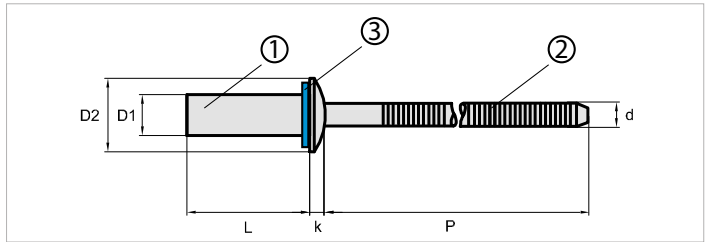
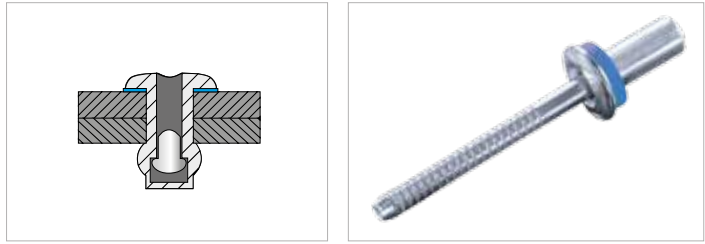

- (1) Body: **AISI 316L STAINLESS STEEL (1.4404)**
 (2) Mandrel: **AISI 318LN STAINLESS STEEL (1.4462)**
 (3) Washer: **HNBR**

ITEM CODE	BODY LENGTH ref.		GRIP RANGE				SHEAR		TENSILE		
	in	mm	in		mm		lbf	kn	lbf	kn	
			min	max	min	max					
1/8" (3.2 mm) D1 = 1/8" 3.2 mm D2 = .240" 6.01 mm k = .050" 1.27 mm d = .074" 1.88 mm P = ≥ 1.063" 27.0 mm .13" 3.3 mm	JBD-41-CE	.297	7.544	.020	.062	0.508	1.575	525	2.34	635	2.82
	JBD-42-CE	.360	9.144	.063	.125	1.600	3.175				
	JBD-43-CE	.422	10.719	.126	.187	3.200	4.750				
	JBD-44-CE	.485	12.319	.188	.250	4.775	6.350				
	JBD-45-CE	.547	13.894	.251	.312	6.375	7.925				
	JBD-46-CE	.610	15.494	.313	.375	7.950	9.525				
	JBD-48-CE	.735	18.669	.376	.500	9.550	12.700				
5/32" (4.0 mm) D1 = 5/32" 4.0 mm D2 = .315" 8.0 mm k = .065" 1.65 mm d = .092" 2.34 mm P = ≥ 1.063" 27.0 mm .161" 4.1 mm	JBD-52-CE	.375	9.525	.020	.125	0.508	3.175	790	3.51	1230	5.47
	JBD-53-CE	.437	11.100	.126	.187	3.200	4.750				
	JBD-54-CE	.500	12.700	.188	.250	4.775	6.350				
	JBD-55-CE	.562	14.275	.251	.312	6.375	7.925				
	JBD-56-CE	.625	15.875	.313	.375	7.950	9.525				
	JBD-58-CE	.750	19.050	.376	.500	9.550	12.700				
3/16" (4.8 mm) D1 = 3/16" 4.8 mm D2 = .375" 9.53 mm k = .080" 2.03 mm d = .110" 2.8 mm P = ≥ 1.063" 27.0 mm .193" 4.9 mm	JBD-62-CE	.406	10.312	.020	.125	0.508	3.175	1220	5.43	1540	6.85
	JBD-63-CE	.468	11.887	.126	.187	3.200	4.750				
	JBD-64-CE	.531	13.487	.188	.250	4.775	6.350				
	JBD-66-CE	.656	16.662	.251	.375	6.375	9.525				
	JBD-68-CE	.781	19.837	.376	.500	9.550	12.700				
	JBD-610-CE	.906	23.012	.501	.625	12.725	15.875				

SLOTTED HEX-HEAD SELF-TAPPING SCREW W/ ASSEMBLED DUPLEX HNBR WASHERS W/ DELTA SEAL COATING SILVER

IMPROVED HEAD DESIGN TO PREVENT STRIPPING

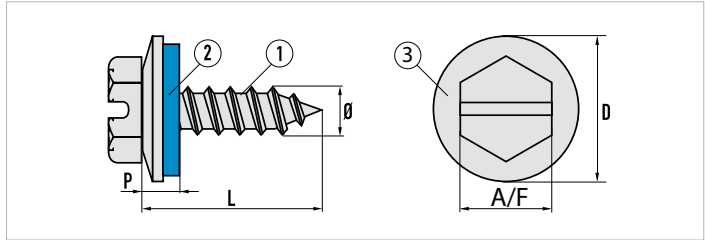

- (1) DUPLEX AISI 318LN (1.4462)
- (2) HNBR SEALING WASHER (BLUE)
- (3) DUPLEX AISI 318LN (1.4462)

Ø #8 4.2 mm
A/F = .275" 7.0 mm
P = .120" 3.0 mm
D = .470" 12.0 mm
 = AB

DESCRIPTION	SIZE		A/F		PACKING UNIT Box Qty.	ITEM CODE
	in	mm	in	mm		
Screw S/S (318LN) HH #8 x 3/8" W/Washer (HNBR)	#8 x 3/8"	4.2 x 9.5	.275"	7.0	500	28220 42950
Screw S/S (318LN) HH #8 x 1/2" W/Washer (HNBR)	#8 x 1/2"	4.2 x 13.0	.275"	7.0	500	28220 42130
Screw S/S (318LN) HH #8 x 5/8" W/Washer (HNBR)	#8 x 5/8"	4.2 x 16.0	.275"	7.0	500	28220 42160
Screw S/S (T318LN) HH #8 x 3/4" W/Washer (HNBR)	#8 x 3/4"	4.2 x 19.0	.275"	7.0	500	28220 42190
Screw S/S (T318LN) HH #8 x 1" W/Washer (HNBR)	#8 x 1"	4.2 x 25.0	.275"	7.0	500	28220 42250

Ø #10 4.8 mm
A/F = .315" 8.0 mm
P = .157" 4.0 mm
D = .470" 12.0 mm
 = AB

Screw S/S (318LN) HH #10 x 3/8" W/Washer (HNBR)	#10 x 3/8"	4.8 x 9.5	.315"	8.0	500	28220 48950
Screw S/S (318LN) HH #10 x 1/2" W/Washer (HNBR)	#10 x 1/2"	4.8 x 13.0	.315"	8.0	500	28220 48130
Screw S/S (318LN) HH #10 x 5/8" W/Washer (HNBR)	#10 x 5/8"	4.8 x 16.0	.315"	8.0	500	28220 48160
Screw S/S (318LN) HH #10 x 3/4" W/Washer (HNBR)	#10 x 3/4"	4.8 x 19.0	.315"	8.0	500	28220 48190
Screw S/S (318LN) HH #10 x 1" W/Washer (HNBR)	#10 x 1"	4.8 x 25.0	.315"	8.0	250	28220 48250

S = A + B	SCREW DIA. Ø	DRILL Ø
S ≤ 0.062" (1.6 mm) = #8 (4.2 mm)		.13" (3.3 mm)
S ≥ 0.062" (1.6 mm) = #10 (4.8 mm)		.157" (4.0 mm)



*Self-Tapping Screws are also available with or without washers.
Options include white Polyamide (6.6) or AISI 316/EPDM Washer.

SLOTTED HEX-HEAD SELF-TAPPING SCREW W/ ASSEMBLED DUPLEX HNBR WASHERS W/ DELTA SEAL COATING SILVER

IMPROVED HEAD DESIGN TO PREVENT STRIPPING



Type A Threads Increase Cost & Time Efficiency by 50%

- (1) DUPLEX AISI 318LN (1.4462)
- (2) HNBR SEALING WASHER (BLUE)
- (3) DUPLEX AISI 318LN (1.4462)

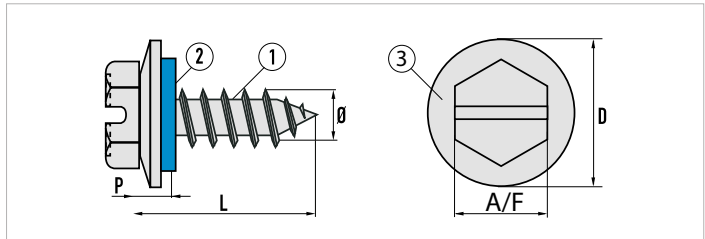

DESCRIPTION	SIZE		A/F		PACKING UNIT Box Qty.	ITEM CODE	
	in	mm	in	mm			
Ø #8 4.3 mm A/F = .275" 7.0 mm P = .120" 3.0 mm D = .470" 12.0 mm = A	Screw S/S (318LN) HH #8 x 3/8" W/Washer (HNBR)	#8 x 3/8"	4.3 x 9.5	.275"	7.0	500	29220 43950
	Screw S/S (318LN) HH #8 x 1/2" W/Washer (HNBR)	#8 x 1/2"	4.3 x 13.0	.275"	7.0	500	29220 43130
	Screw S/S (318LN) HH #8 x 5/8" W/Washer (HNBR)	#8 x 5/8"	4.3 x 16.0	.275"	7.0	500	29220 43160
	Screw S/S (318LN) HH #8 x 3/4" W/Washer (HNBR)	#8 x 3/4"	4.3 x 19.0	.275"	7.0	500	29220 43190
	Screw S/S (318LN) HH #8 x 1" W/Washer (HNBR)	#8 x 1"	4.3 x 25.0	.275"	7.0	500	29220 43250

- Ø #10 4.9 mm**
 A/F = .315" 8.0 mm
 P = .157" 4.0 mm
 D = .470" 12.0 mm
 = A

Screw S/S (318LN) HH #10 x 3/8" W/Washer (HNBR)	#10 x 3/8"	4.9 x 9.5	.315"	8.0	500	29220 49950
Screw S/S (318LN) HH #10 x 1/2" W/Washer (HNBR)	#10 x 1/2"	4.9 x 13.0	.315"	8.0	500	29220 49130
Screw S/S (318LN) HH #10 x 5/8" W/Washer (HNBR)	#10 x 5/8"	4.9 x 16.0	.315"	8.0	500	29220 49160
Screw S/S (318LN) HH #10 x 3/4" W/Washer (HNBR)	#10 x 3/4"	4.9 x 19.0	.315"	8.0	500	29220 49190
Screw S/S (318LN) HH #10 x 1" W/Washer (HNBR)	#10 x 1"	4.9 x 25.0	.315"	8.0	250	29220 49250

S = A + B	SCREW DIA. Ø	DRILL Ø
S ≤ 0.062" (1.6 mm)	= #8 (4.2 mm)	.13" (3.3 mm)
S ≥ 0.062" (1.6 mm)	= #10 (4.8 mm)	.157" (4.0 mm)

*Self-Tapping Screws are also available with or without washers.
Options include white Polyamide (6.6) or AISI 316/EPDM Washer.

ROBERTSON PAN-HEAD SELF-TAPPING SCREW W/ ASSEMBLED DUPLEX HNBR WASHERS W/ DELTA SEAL COATING SILVER

IMPROVED HEAD DESIGN TO PREVENT STRIPPING

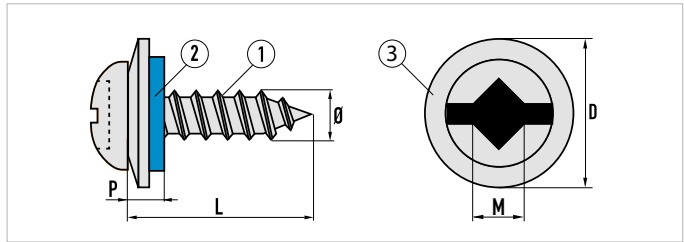

- (1) DUPLEX AISI 318LN (1.4462)
- (2) HNBR SEALING WASHER (BLUE)
- (3) DUPLEX AISI 318LN (1.4462)

Ø #8 4.2 mm
M = No.2
P = .120" 3.0 mm
D = .470" 12.0 mm
 = AB

DESCRIPTION	SIZE		M	PACKING UNIT	ITEM CODE
	in	mm			
SQ Screw S/S (318LN) #8 x 3/8" W/Washer (HNBR)	#8 x 3/8"	4.2 x 9.5	2	500	28221 42950
SQ Screw S/S (318LN) #8 x 1/2" W/Washer (HNBR)	#8 x 1/2"	4.2 x 13.0	2	500	28221 42130
SQ Screw S/S (318LN) #8 x 5/8" W/Washer (HNBR)	#8 x 5/8"	4.2 x 16.0	2	500	28221 42160
SQ Screw S/S (T318LN) #8 x 3/4" W/Washer (HNBR)	#8 x 3/4"	4.2 x 19.0	2	500	28221 42190
SQ Screw S/S (T318LN) #8 x 1" W/Washer (HNBR)	#8 x 1"	4.2 x 25.0	2	500	28221 42250

Ø #10 4.8 mm
M = No.2
P = .157" 4.0 mm
D = .470" 12.0 mm
 = AB

SQ Screw S/S (318LN) #10 x 3/8" W/Washer (HNBR)	#10 x 3/8"	4.8 x 9.5	2	500	28221 48950
SQ Screw S/S (318LN) #10 x 1/2" W/Washer (HNBR)	#10 x 1/2"	4.8 x 13.0	2	500	28221 48130
SQ Screw S/S (318LN) #10 x 5/8" W/Washer (HNBR)	#10 x 5/8"	4.8 x 16.0	2	500	28221 48160
SQ Screw S/S (318LN) #10 x 3/4" W/Washer (HNBR)	#10 x 3/4"	4.8 x 19.0	2	500	28221 48190
SQ Screw S/S (318LN) #10 x 1" W/Washer (HNBR)	#10 x 1"	4.8 x 25.0	2	250	28221 48250

S = A + B	SCREW DIA. Ø	DRILL Ø
S ≤ 0.062" (1.6 mm)	= #8 (4.2 mm)	.13" (3.3 mm)
S ≥ 0.062" (1.6 mm)	= #10 (4.8 mm)	.157" (4.0 mm)



*Self-Tapping Screws are also available with or without washers.
Options include white Polyamide (6.6) or AISI 316/EPDM Washer.

ROBERTSON PAN-HEAD SELF-TAPPING SCREW W/ ASSEMBLED DUPLEX HNBR WASHERS W/ DELTA SEAL COATING SILVER

IMPROVED HEAD DESIGN TO PREVENT STRIPPING

Type A Threads Increase Cost & Time Efficiency by 50%

- (1) DUPLEX AISI 318LN (1.4462)
- (2) HNBR SEALING WASHER (BLUE)
- (3) DUPLEX AISI 318LN (1.4462)

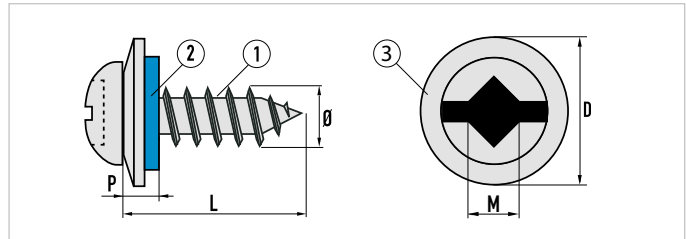

DESCRIPTION	SIZE		M	PACKING UNIT	ITEM CODE	
	in	mm				
Ø #8 4.3 mm M = No.2 P = .120" 3.0 mm D = .470" 12.0 mm = A	SQ Screw S/S (318LN) #8 x 3/8" W/Washer (HNBR)	#8 x 3/8"	4.3 x 9.5	2	500	29221 43950
	SQ Screw S/S (318LN) #8 x 1/2" W/Washer (HNBR)	#8 x 1/2"	4.3 x 13.0	2	500	29221 43130
	SQ Screw S/S (318LN) #8 x 5/8" W/Washer (HNBR)	#8 x 5/8"	4.3 x 16.0	2	500	29221 43160
	SQ Screw S/S (318LN) #8 x 3/4" W/Washer (HNBR)	#8 x 3/4"	4.3 x 19.0	2	500	29221 43190
	SQ Screw S/S (318LN) #8 x 1" W/Washer (HNBR)	#8 x 1"	4.3 x 25.0	2	500	29221 43250

- Ø #10 4.9 mm**
- M = No.2
- P = .157" 4.0 mm
- D = .470" 12.0 mm
- = A

SQ Screw S/S (318LN) #10 x 3/8" W/Washer (HNBR)	#10 x 3/8"	4.9 x 9.5	2	500	29221 49950
SQ Screw S/S (318LN) #10 x 1/2" W/Washer (HNBR)	#10 x 1/2"	4.9 x 13.0	2	500	29221 49130
SQ Screw S/S (318LN) #10 x 5/8" W/Washer (HNBR)	#10 x 5/8"	4.9 x 16.0	2	500	29221 49160
SQ Screw S/S (318LN) #10 x 3/4" W/Washer (HNBR)	#10 x 3/4"	4.9 x 19.0	2	500	29221 49190
SQ Screw S/S (318LN) #10 x 1" W/Washer (HNBR)	#10 x 1"	4.9 x 25.0	2	250	29221 49250

S = A + B	SCREW DIA. Ø	DRILL Ø
S ≤ 0.062" (1.6 mm)	= #8 (4.2 mm)	.13" (3.3 mm)
S ≥ 0.062" (1.6 mm)	= #10 (4.8 mm)	.157" (4.0 mm)

*Self-Tapping Screws are also available with or without washers.
Options include white Polyamide (6.6) or AISI 316/EPDM Washer.



NUT DRIVER WITH BALL LOCK

EXCLUSIVE BALL LOCK DESIGN PROVIDES ADDITIONAL RETENTION SUPPORT
MADE OF STAINLESS STEEL AISI 304

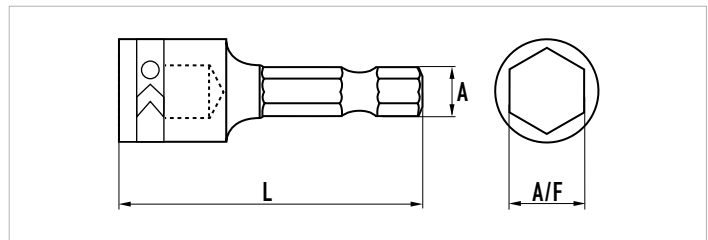

A = 1/4" (6.35 mm)

LENGTH		A/F		PACKING UNIT	ITEM CODE
in	mm	in	mm	Box Qty.	
1"	50	.275"	7.0	5	50006 05507
1"	50	.315"	8.0	5	50006 05508

SQ - POWERBIT

FOR SQUARE DRIVE SCREWS
MADE OF STAINLESS STEEL AISI 304

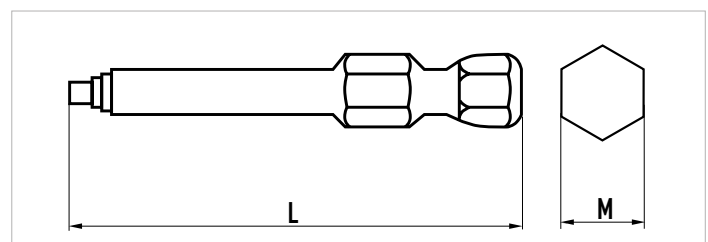

A = 1/4" (6.35 mm)

LENGTH		M	PACKING UNIT	ITEM CODE
in	mm	No.	Box Qty.	
3 1/2"	89	2	5	00000 00054

NOTES



INNOVATIVE FASTENER SOLUTIONS

NOTES





**35 YEARS
OF
EXCEEDING EXPECTATIONS**



GOEBEL FASTENERS INC.
5650 GUHN ROAD. SUITE 110
HOUSTON, TX 77040
PHONE: + 1 (713) 393 7007
SALES@GOBELFASTENERS.COM

WWW.GOBELFASTENERS.COM